



## 240pin Registered DDR2 SDRAM DIMMs based on 1Gb version C

This Hynix Registered Dual In-Line Memory Module (DIMM) series consists of 1Gb version C DDR2 SDRAMs in Fine Ball Grid Array (FBGA) packages on a 240pin glass-epoxy substrate. This Hynix 1Gb version C based Registered DDR2 DIMM series provide a high performance 8 byte interface in 5.25" width form factor of industry standard. It is suitable for easy interchange and addition.

### FEATURES

- JEDEC standard Double Data Rate2 Synchronous DRAMs (DDR2 SDRAMs) with 1.8V +/- 0.1V Power Supply
- All inputs and outputs are compatible with SSTL\_1.8 interface
- 8 Bank architecture
- Posted CAS
- Programmable CAS Latency 3, 4, 5, 6
- OCD (Off-Chip Driver Impedance Adjustment)
- ODT (On-Die Termination)
- Fully differential clock operations (CK & CK)
- Programmable Burst Length 4 / 8 with both sequential and interleave mode
- Auto refresh and self refresh supported
- 8192 refresh cycles / 64ms
- Serial presence detect with EEPROM
- DDR2 SDRAM Package: 60 ball(x4/x8)
- 133.35 x 30.00 mm form factor
- RoHS compliant

### ORDERING INFORMATION

Part Name	Density	Organization	# of DRAMs	# of ranks	Parity Support
HYMP112P72CP8-C4/Y5/S6/S5	1GB	128Mx72	9	1	O
HYMP125P72CP8-C4/Y5/S6/S5	2GB	256Mx72	18	2	O
HYMP125P72CP4-C4/Y5/S6/S5	2GB	256Mx72	18	1	O
HYMP151P72CP8-C4/Y5/S6/S5	4GB	512Mx72	36	4	O
HYMP151P72CP4-C4/Y5/S6/S5	4GB	512Mx72	36	2	O
HYMP31GP72CMP4-C4/Y5	8GB	512Mx72	72	4	O
HYMP112R72CP8-E3/C4	1GB	128Mx72	9	1	X
HYMP125R72CP4-E3/C4	2GB	256Mx72	18	1	X
HYMP151R72CP4-E3/C4	4GB	512Mx72	36	2	X

This document is a general product description and is subject to change without notice. Hynix Semiconductor does not assume any responsibility for use of circuits described. No patent licenses are implied.

**SPEED GRADE & KEY PARAMETERS**

	<b>E3 (DDR2-400)</b>	<b>C4 (DDR2-533)</b>	<b>Y5 (DDR2-667)</b>	<b>S6 (DDR2-800)</b>	<b>S5 (DDR2-800)</b>	<b>Unit</b>
Speed@CL3	400	400	400	-	400	Mbps
Speed@CL4	-	533	533	533	533	Mbps
Speed@CL5	-	-	667	667	800	Mbps
Speed@CL6	-	-	-	800	-	Mbps
CL-tRCD-tRP	3-3-3	4-4-4	5-5-5	6-6-6	5-5-5	tCK

**ADDRESS TABLE**

<b>Density</b>	<b>Organization</b>	<b>Ranks</b>	<b>SDRAMs</b>	<b># of DRAMs</b>	<b># of row/bank/column Address</b>	<b>Refresh Method</b>
<b>1GB</b>	128M x 72	1	128Mb x 8	9	14(A0~A13)/3(BA0~BA2)/10(A0~A9)	8K / 64ms
<b>2GB</b>	256M x 72	2	128Mb x 8	18	14(A0~A13)/3(BA0~BA2)/10(A0~A9)	8K / 64ms
<b>2GB</b>	256M x 72	1	256Mb x 4	18	14(A0~A13)/3(BA0~BA2)/11(A0~A9,A11)	8K / 64ms
<b>4GB</b>	512M x 72	4	128Mb x 8	36	14(A0~A13)/3(BA0~BA2)/10(A0~A9)	8K / 64ms
<b>4GB</b>	512M x 72	2	256Mb x 4	36	14(A0~A13)/3(BA0~BA2)/11(A0~A9,A11)	8K / 64ms
<b>8GB</b>	1G x 72	4	256Mb x 4	72	14(A0~A13)/3(BA0~BA2)/11(A0~A9,A11)	8K / 64ms

**Input/Output Functional Description**

Symbol	Type	Polarity	Pin Description
CK0	IN	Positive Edge	Positive line of the differential pair of system clock inputs that drives input to the on-DIMM PLL.
$\overline{CK0}$	IN	Negative Edge	Negative line of the differential pair of system clock inputs that drives input to the on-DIMM PLL.
CKE[1:0]	IN	Active High	Activates the DDR2 SDRAM CK signal when high and deactivates the CK signal when low. By deactivating the clocks, CKE low initiates the Power Down mode or the Self Refresh mode.
$\overline{S}$ [1:0]	IN	Active Low	Enables the associated DDR2 SDRAM command decoder when low and disables the command decoder when high. When the command decoder is disabled, new commands are ignored but previous operations continue. Rank 0 is selected by S0; Rank 1 is selected by S1
ODT[1:0]	IN	Active High	On-Die Termination signals.
$\overline{RAS}$ , $\overline{CAS}$ , $\overline{WE}$	IN	Active Low	When sampled at the positive rising edge of the clock. $\overline{RAS}$ , $\overline{CAS}$ and $\overline{WE}$ (ALONG WITH S) define the command being entered.
Vref	Supply		Reference voltage for SSTL18 inputs
V <sub>DDQ</sub>	Supply		Power supplies for the DDR2 SDRAM output buffers to provide improved noise immunity. For all current DDR2 unbuffered DIMM designs, V <sub>DDQ</sub> shares the same power plane as V <sub>DD</sub> pins.
BA[2:0]	IN	-	Selects which DDR2 SDRAM internal bank of Eight is activated.
A[9:0], A10/AP A[13:11]	IN	-	During a Bank Activate command cycle, Address input defines the row address (RA0~RA13)  During a Read or Write command cycle, Address input defines the column address when sampled at the cross point of the rising edge of CK and falling edge of CK. In addition to the column address, AP is used to invoke autoprecharge operation at the end of the burst read or write cycle. If AP is high, autoprecharge is selected and BA0-BAn defines the bank to be precharged. If AP is low, autoprecharge is disabled. During a Precharge command cycle, AP is used in conjunction with BA0-BAn to control which bank(s) to precharge. If AP is high, all banks will be precharged regardless of the state of BA0-BAn inputs. If AP is low, then BA0-BAn are used to define which bank to precharge.
DQ[63:0], CB[7:0]	IN	-	Data and Check Bit Input/Output pins.
DM[8:0]	IN	Active High	DM is an input mask signal for write data. Input data is masked when DM is sampled High coincident with that input data during a write access. DM is sampled on both edges of DQS. Although DM pins are input only, the DM loading matches the DQ and DQS loading.
V <sub>DD</sub> , V <sub>SS</sub>	Supply		Power and ground for the DDR2 SDRAM input buffers, and core logic. V <sub>DD</sub> and V <sub>DDQ</sub> pins are tied to V <sub>DD</sub> /V <sub>DDQ</sub> planes on these modules.
DQS[17:0]	I/O	Positive Edge	Positive line of the differential data strobe for input and output data
$\overline{DQS}$ [17:0]	I/O	Negative Edge	Negative line of the differential data strobe for input and output data
SA[2:0]	IN	-	These signals are tied at the system planar to either V <sub>SS</sub> or V <sub>DDSPD</sub> to configure the serial SPD EEPROM address range.
SDA	I/O	-	This is a bidirectional pin used to transfer data into or out of the SPD EEPROM. A resistor may be connected from the SDA bus line to V <sub>DDSPD</sub> on the system planar to act as a pull up.
SCL	IN	-	This signal is used to clock data into and out of the SPD EEPROM. A resistor may be connected from SCL to V <sub>DDSPD</sub> to act as a pull up on the system board.
VDDSPD	Supply		Power supply for SPD EEPROM. This supply is separate from the VDD/VDDQ power plane. EEPROM supply is operable from 1.7V to 3.6V.
RESET	IN		The RESET pin is connected to the RST pin on the register and to the OE pin on the PLL. When low, all register outputs will be driven low and the PLL clocks to the DRAMs and register(s) will be set to low level (the PLL will remain synchronized with the input clock)
Par_In	IN		Parity bit for the Address and Control bus ("1". Odd, "0". Even)
Err_Out	OUT		Parity error found in the Address and Control bus
TEST			Used by memory bus analysis tools (unused on memory DIMMs)

**PIN DESCRIPTION**

Pin	Pin Description	Pin	Pin Description
CK0	Clock Input, positive line	ODT[1:0]	On Die Termination Inputs
$\overline{\text{CK0}}$	Clock input, negative line	VDDQ	DQs Power Supply
CKE0~CKE1	Clock Enable Input	DQ0~DQ63	Data Input/Output
$\overline{\text{RAS}}$	Row Address Strobe	CB0~CB7	Data check bits Input/Output
$\overline{\text{CAS}}$	Column Address Strobe	DQS(0~8)	Data strobes
$\overline{\text{WE}}$	Write Enable	$\overline{\text{DQS}}$ (0~8)	Data strobes, negative line
$\overline{\text{S0}}, \overline{\text{S1}}$	Chip Select Input	DM(0~8), DQS(9~17)	Data Masks/Data strobes
A0~A9, A11~A13	Address input	DQS(9~17)	Data strobes, negative line
A10/AP	Address input/Autoprecharge	RFU	Reserved for Future Use
BA0, BA1, BA2	SDRAM Bank Address	NC	No Connect
SCL	Serial Presence Detect (SPD) Clock Input	TEST	Memory bus test tool (Not Connected and Not Usable on DIMMs)
SDA	SPD Data Input/Output	VDD	Core Power
SA0~SA2	E <sup>2</sup> PROM Address Inputs	VDDQ	I/O Power Supply
Par_In	Parity bit for the Address and Control bus	VSS	Ground
$\overline{\text{Err\_Out}}$	Parity error found on the Adresse	VREF	Reference Power Supply
$\overline{\text{RESET}}$	Reset Enable	VDDSPD	Power Supply for SPD
CB0~CB7	Data Strobe Inputs/Outputs		

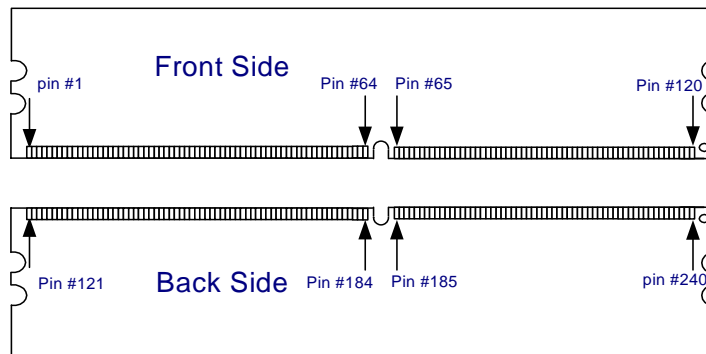
**PIN LOCATION**

**PIN ASSIGNMENT**

Pin	Name	Pin	Name	Pin	Name	Pin	Name	Pin	Name	Pin	Name
1	VREF	41	VSS	81	DQ33	121	VSS	161	CB4	201	VSS
2	VSS	42	CB0	82	VSS	122	DQ4	162	CB5	202	DM4/DQS13
3	DQ0	43	CB1	83	$\overline{\text{DQS}}4$	123	DQ5	163	VSS	203	$\overline{\text{DQS}}13$
4	DQ1	44	VSS	84	DQS4	124	VSS	164	DM8,DQS17	204	VSS
5	VSS	45	$\overline{\text{DQS}}8$	85	VSS	125	DM0/DQS9	165	$\overline{\text{DQS}}17$	205	DQ38
6	$\overline{\text{DQS}}0$	46	DQS8	86	DQ34	126	$\overline{\text{DQS}}9$	166	VSS	206	DQ39
7	DQS0	47	VSS	87	DQ35	127	VSS	167	CB6	207	VSS
8	VSS	48	CB2	88	VSS	128	DQ6	168	CB7	208	DQ44
9	DQ2	49	CB3	89	DQ40	129	DQ7	169	VSS	209	DQ45
10	DQ3	50	VSS	90	DQ41	130	VSS	170	VDDQ	210	VSS
11	VSS	51	VDDQ	91	VSS	131	DQ12	171	NC,CKE1	211	DM5/DQS14
12	DQ8	52	CKE0	92	$\overline{\text{DQS}}5$	132	DQ13	172	VDD	212	$\overline{\text{DQS}}14$
13	DQ9	53	VDD	93	DQS5	133	VSS	173	A15,NC	213	VSS
14	VSS	54	BA2,NC	94	VSS	134	DM1/DQS10	174	A14,NC	214	DQ46
15	$\overline{\text{DQS}}1$	55	NC, Err_Out	95	DQ42	135	$\overline{\text{DQS}}10$	175	VDDQ	215	DQ47
16	DQS1	56	VDDQ	96	DQ43	136	VSS	176	A12	216	VSS
17	VSS	57	A11	97	VSS	137	RFU	177	A9	217	DQ52
18	RESET	58	A7	98	DQ48	138	RFU	178	VDD	218	DQ53
19	NC	59	VDD	99	DQ49	139	$\overline{\text{VSS}}$	179	A8	219	VSS
20	VSS	60	A5	100	VSS	140	DQ14	180	A6	220	RFU
21	DQ10	61	A4	101	SA2	141	DQ15	181	VDDQ	221	RFU
22	DQ11	62	VDDQ	102	NC(TEST)	142	VSS	182	A3	222	VSS
23	VSS	63	A2	103	VSS	143	DQ20	183	A1	223	DM6/DQS15
24	DQ16	64	VDD	104	$\overline{\text{DQS}}6$	144	DQ21	184	VDD	224	NC, $\overline{\text{DQS}}15$
25	DQ17	Key		105	DQS6	145	VSS	Key		225	VSS
26	VSS	65	VSS	106	VSS	146	DM2/DQS11	185	CK0	226	DQ54
27	$\overline{\text{DQS}}2$	66	VSS	107	DQ50	147	$\overline{\text{DQS}}11$	186	$\overline{\text{CK}}0$	227	DQ55
28	DQS2	67	VDD	108	DQ51	148	VSS	187	VDD	228	VSS
29	VSS	68	NC, Err_Out	109	VSS	149	DQ22	188	A0	229	DQ60
30	DQ18	69	VDD	110	DQ56	150	DQ23	189	VDD	230	DQ61
31	DQ19	70	A10/AP	111	DQ57	151	VSS	190	BA1	231	VSS
32	VSS	71	BA0	112	VSS	152	DQ28	191	VDDQ	232	DM7/DQS16
33	DQ24	72	VDDQ	113	$\overline{\text{DQS}}7$	153	DQ29	192	$\overline{\text{RAS}}$	233	NC, $\overline{\text{DQS}}16$
34	DQ25	73	$\overline{\text{WE}}$	114	DQS7	154	VSS	193	$\overline{\text{S}}0$	234	VSS
35	VSS	74	$\overline{\text{CAS}}$	115	VSS	155	DM3/DQS12	194	VDDQ	235	DQ62
36	$\overline{\text{DQS}}3$	75	VDDQ	116	DQ58	156	$\overline{\text{DQS}}12$	195	ODT0	236	DQ63
37	DQS3	76	NC, $\overline{\text{S}}1$	117	DQ59	157	VSS	196	A13,NC	237	VSS
38	VSS	77	NC, ODT1	118	VSS	158	DQ30	197	VDD	238	VDDSPD
39	DQ26	78	VDDQ	119	SDA	159	DQ31	198	VSS	239	SA0
40	DQ27	79	VSS	120	SCL	160	VSS	199	DQ36	240	SA1
		80	DQ32					200	DQ37		

NC= No Connect, RFU= Reserved for Future Use.

**Note:**

1. RESET (Pin 18) is connected to both OE of PLL and Reset of register.
2. NC/Err\_out (Pin 55) and NC/Par\_In(Pin68) are for optional function to check address and command parity.
3. The Test pin (Pin 102) is reserved for bus analysis probes and is not connected on normal memory modules (DIMMs)

**FUNCTIONAL BLOCK DIAGRAM**  
**1GB(128Mbx72) : HYMP112[R,P]72CP8**

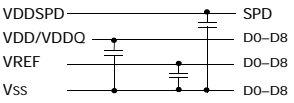
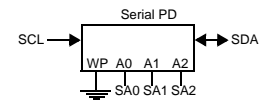
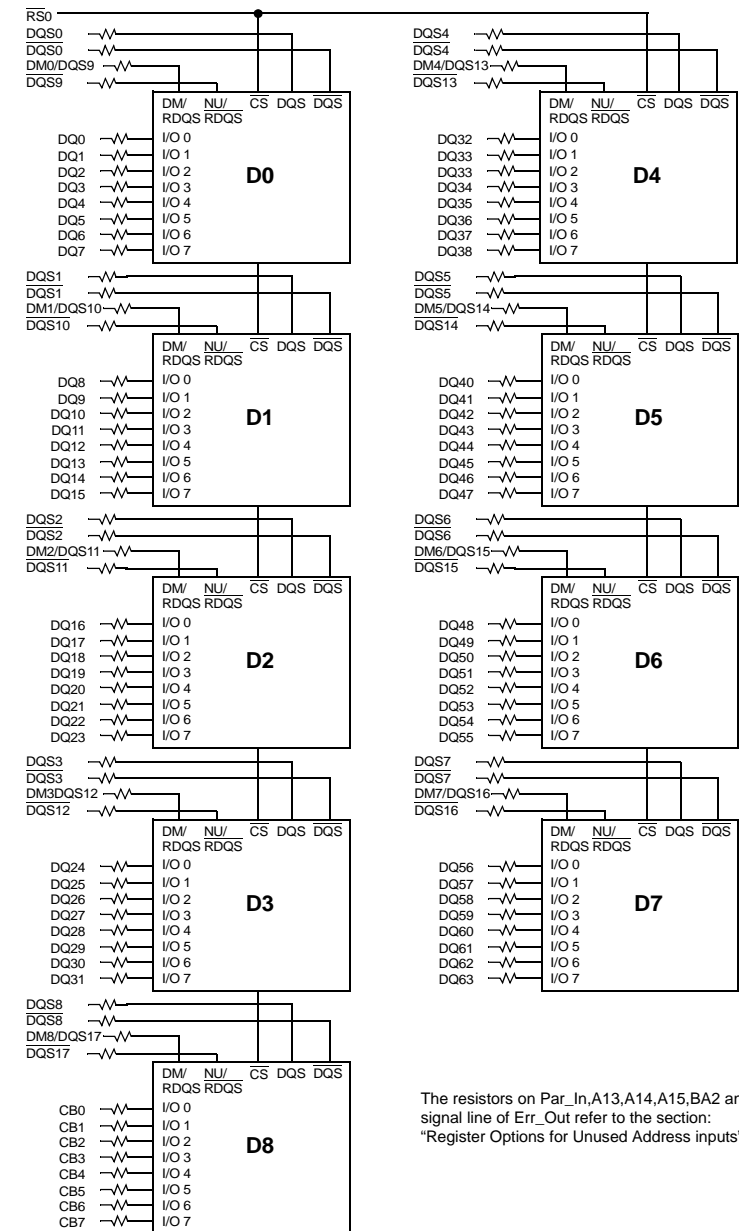

**Note:**  
 1. DQ-to-I/O wiring may be changed within a nibble.  
 2. Unless otherwise noted, resistor values are 22 Ohms ± 5%.

The resistors on Par\_In,A13,A14,A15,BA2 and the signal line of Err\_Out refer to the section: "Register Options for Unused Address inputs"

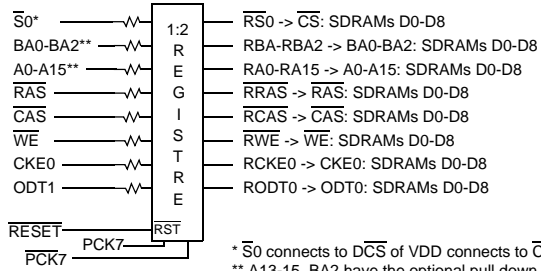
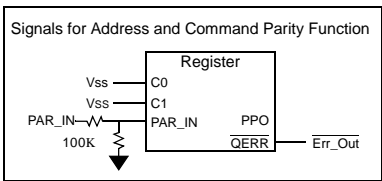

\* S0 connects to DC $\overline{S}$  of VDD connects to CS $\overline{R}$  on the register. S1, CKE1 and ODT1 are NC.  
 \*\* A13-15, BA2 have the optional pull down resistors (100K ohms), which is not indicated here.

## FUNCTIONAL BLOCK DIAGRAM 2GB(256Mbx72): HYMP125P72CP8

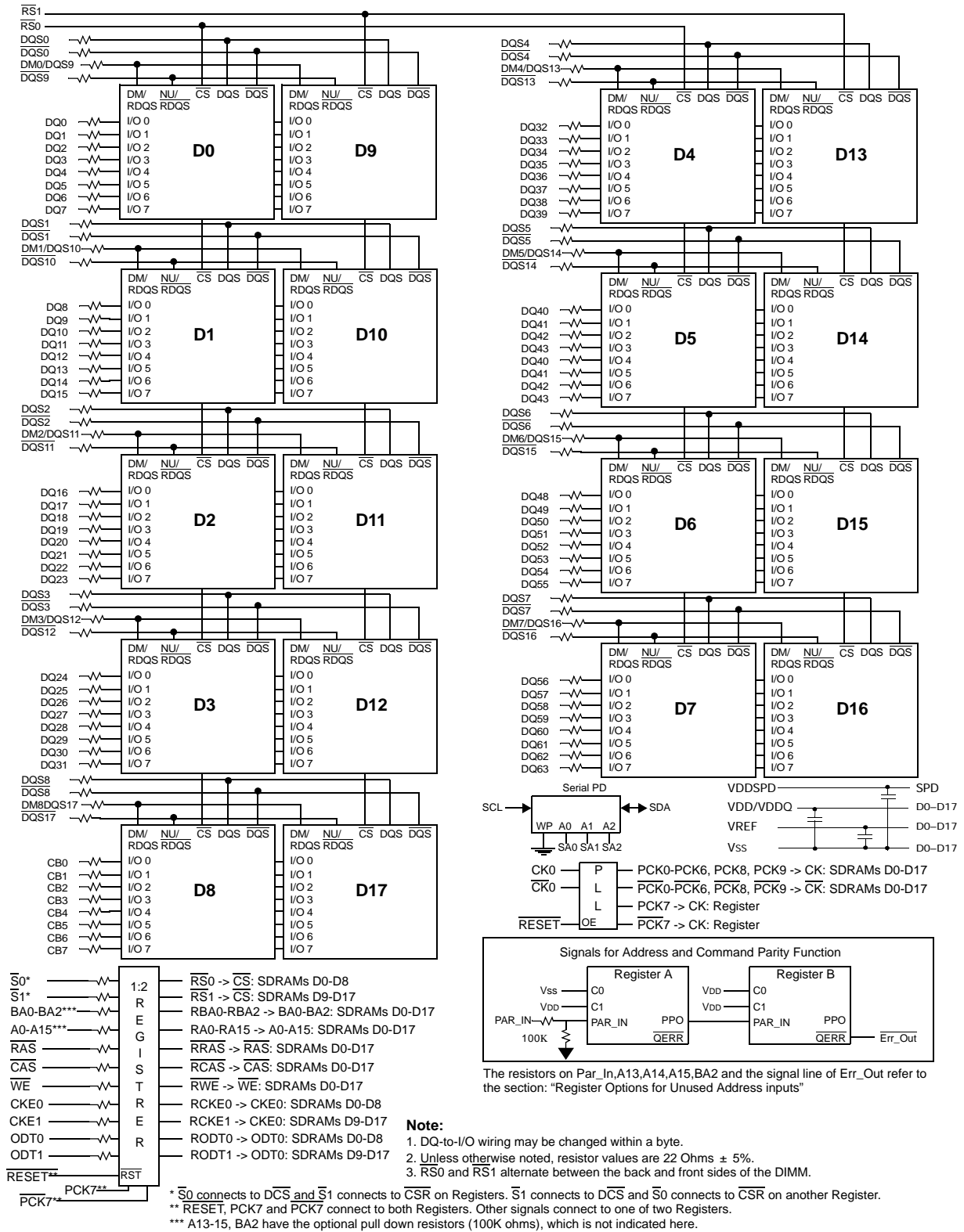

## FUNCTIONAL BLOCK DIAGRAM 2GB(256Mbx72): HYMP125[R,P]72CP4

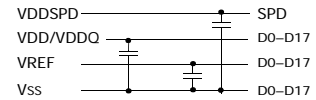
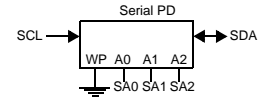
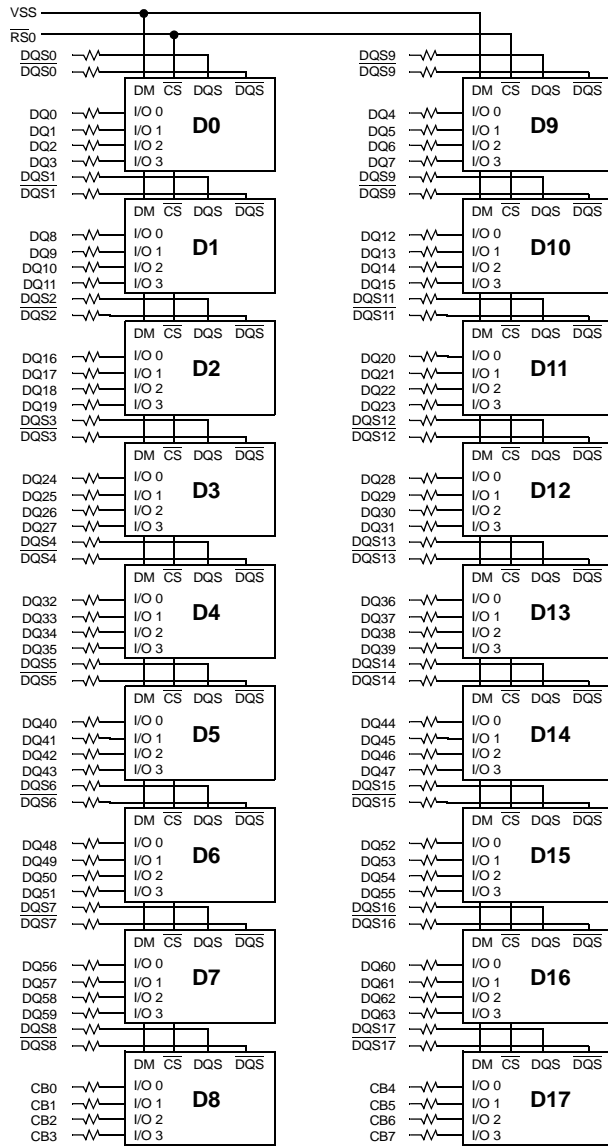

**Note:**

1. DQ-to-I/O wiring may be changed within a nibble.
2. Unless otherwise noted, resistor values are 22 Ohms  $\pm$  5%.

\*  $\overline{S0}$  connects to  $\overline{DCS}$  of Register A and  $\overline{CSR}$  of Register B.  $\overline{CSR}$  of Register A and  $\overline{DCS}$  of Register B connects to VDD.

\*\*  $\overline{RESET}$ ,  $\overline{PCK7}$  and  $\overline{PCK7}$  connects to both Registers. Other signals connect to one of two Registers.

\*\*\* A13-15, BA2 have the optional pull down resistors (100K ohms), which is not indicated here.

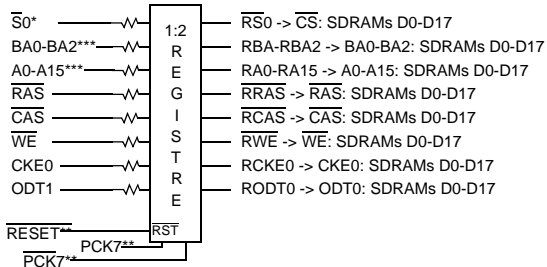

The resistors on Par\_In,A13,A14,A15,BA2 and the signal line of Err\_Out refer to the section: "Register Options for Unused Address inputs"

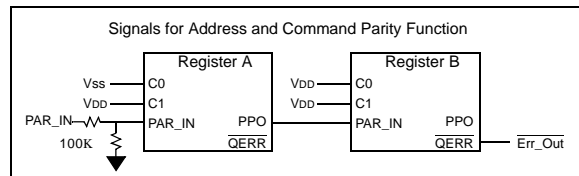



## FUNCTIONAL BLOCK DIAGRAM 4GB(512Mbx72): HYMP151P72CP8

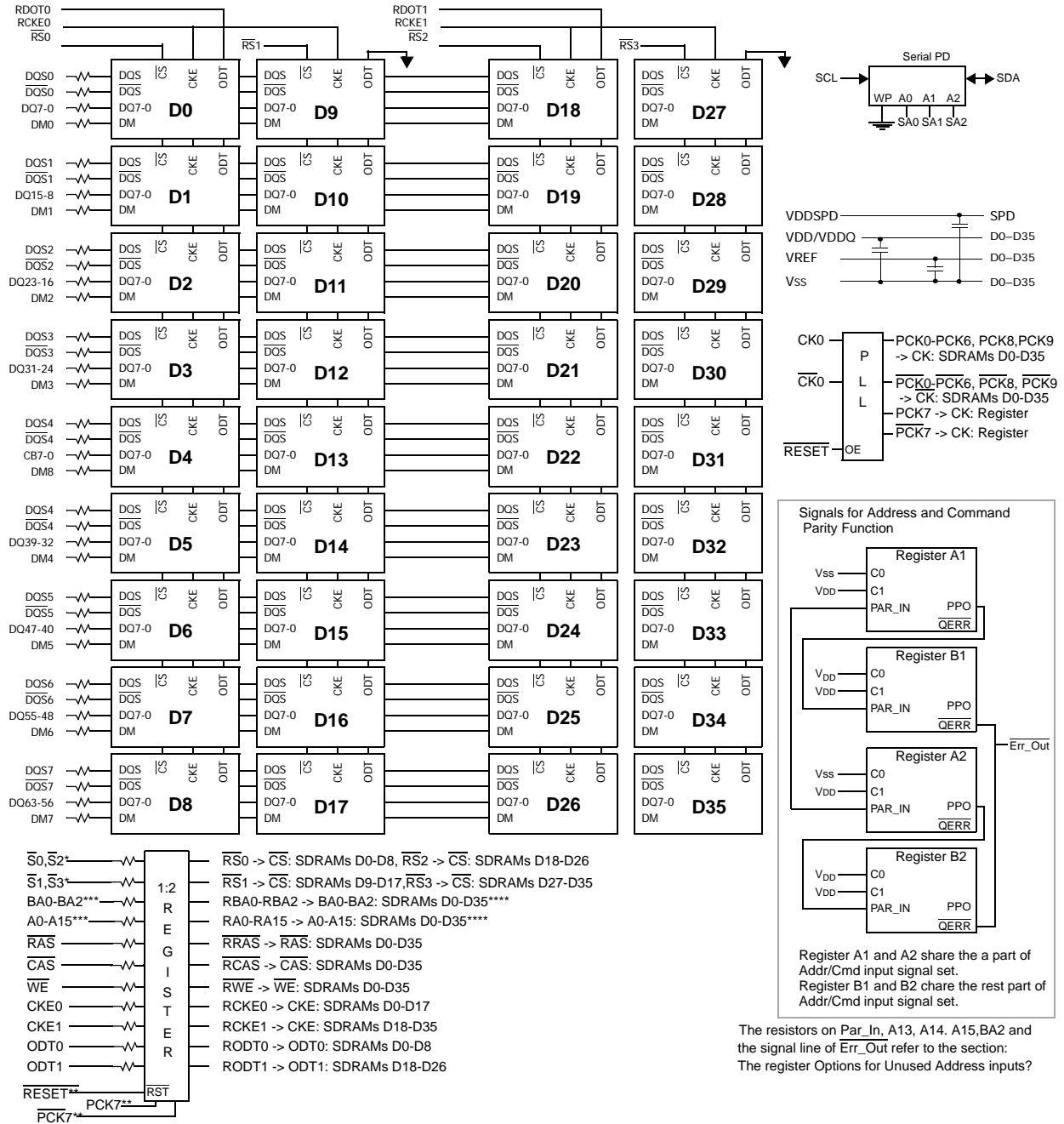

\*  $\overline{S0}$  ( $\overline{S2}$ ) connects to  $\overline{DCS0}$ ,  $\overline{S1}$  ( $\overline{S3}$ ) to  $\overline{DCS1}$  on a Register A.  $\overline{S1}$  ( $\overline{S3}$ ) connects to  $\overline{DCS}$  and  $\overline{S0}$  ( $\overline{S2}$ ) connects to  $\overline{CSR}$  on another pair of Register.  
 \*\*  $\overline{S2}$  and  $\overline{S3}$  have required pull up resistors (100k ohms), not indicated here.  
 \*\*\* RESET, PCK7 and PCK7 connect to all Registers. Other signals connect to two of four Registers.  
 \*\*\*\* A13-15, BA2 have the optional pull down resistors(100K ohms), which is not indicated here.  
 \*\*\*\*\* For Raw Card N2, DQ stub resistor value is TBD.  
 And for Raw Card N2, post register A14 and A15 are not connected to the SDRAMs.

**FUNCTIONAL BLOCK DIAGRAM**  
**4GB(512Mbx72): HYMP151[R,P]72CP4**

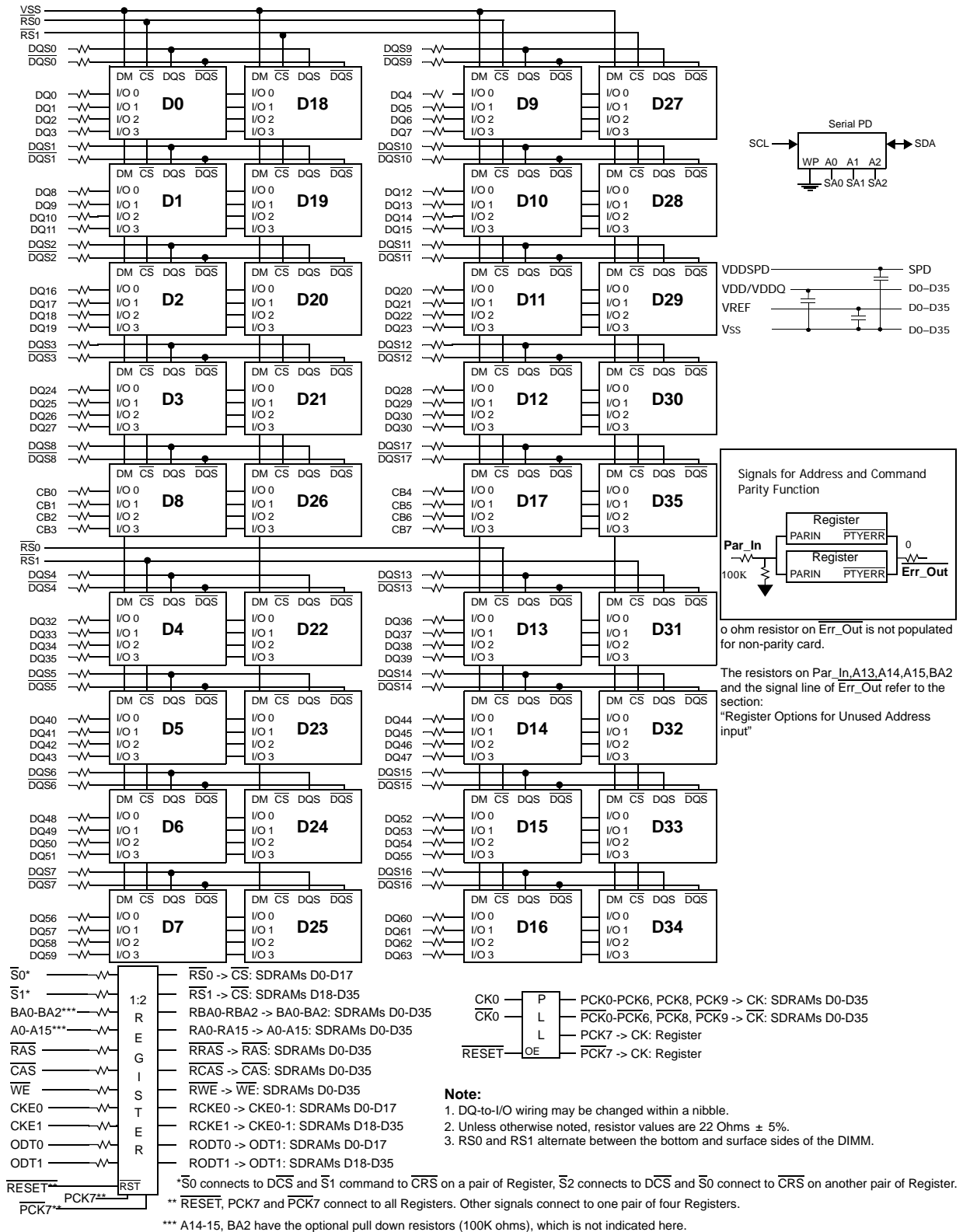

## FUNCTIONAL BLOCK DIAGRAM 8GB(1Gbx72): HYMP31GP72CMP4

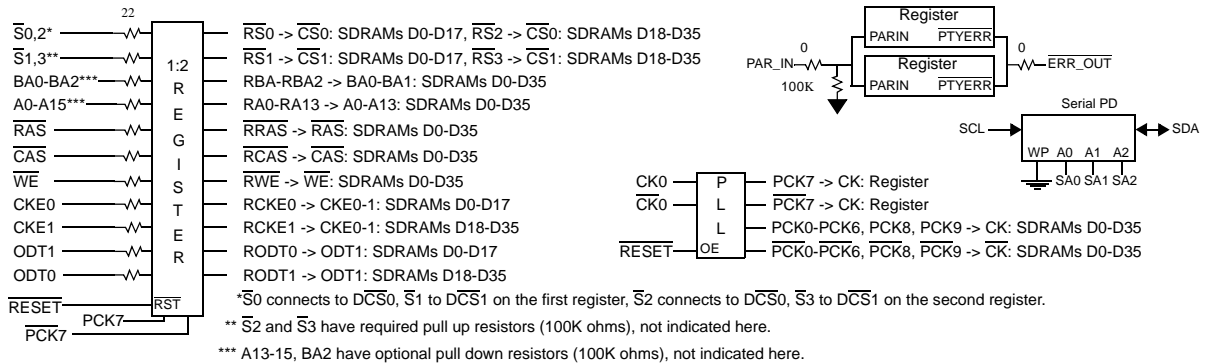
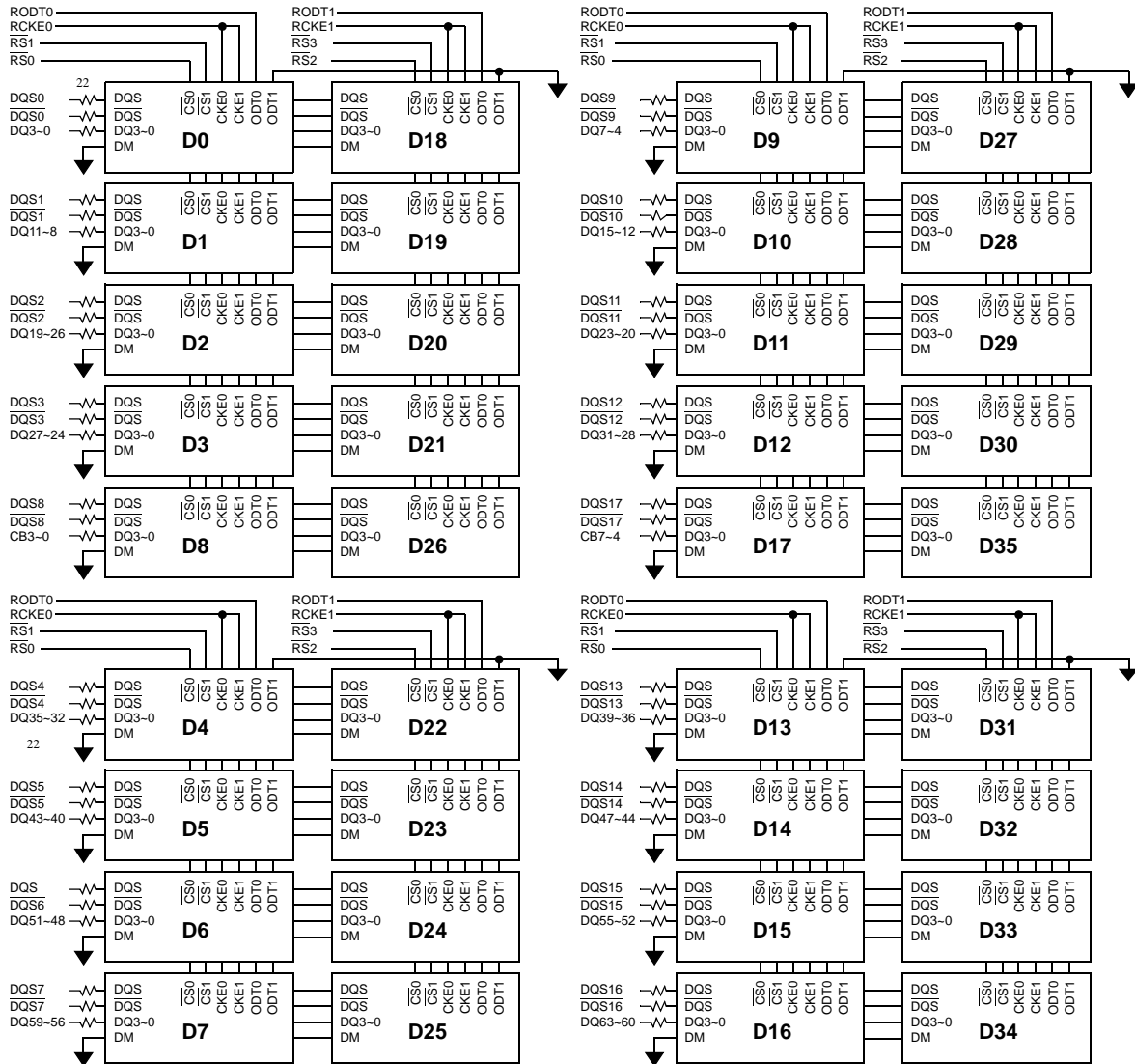

**ABSOLUTE MAXIMUM DC RATINGS**

Parameter	Symbol	Value	Unit	Note
Voltage on V <sub>DD</sub> pin relative to V <sub>SS</sub>	V <sub>DD</sub>	- 1.0 ~ 2.3	V	1
Voltage on V <sub>DDQ</sub> pin relative to V <sub>SS</sub>	V <sub>DDQ</sub>	- 0.5 ~ 2.3	V	1
Voltage on V <sub>DDL</sub> pin relative to V <sub>SS</sub>	V <sub>DDL</sub>	- 0.5 ~ 2.3	V	1
Voltage on any pin relative to V <sub>SS</sub>	V <sub>IN</sub> , V <sub>OUT</sub>	- 0.5 ~ 2.3	V	1

**Operating Conditions and Environmental Parameters**

Parameter	Symbol	Rating	Units	Notes
DIMM Operating temperature (ambient)	T <sub>OPR</sub>	0 ~ +55	°C	
Storage Temperature	T <sub>STG</sub>	-50 ~ +100	°C	1
Storage Humidity (without condensation)	H <sub>STG</sub>	5 to 95	%	1
DIMM Barometric Pressure (operating & storage)	p <sub>BAR</sub>	105 to 69	K Pascal	2
DRAM Component Case Temperature Range	T <sub>CASE</sub>	0 ~ +95	°C	3

**Note:**

1. Stress greater than those listed may cause permanent damage to the device. This is a stress rating only, and device functional operation at or above the conditions indicated is not implied. Exposure to absolute maximum rating conditions for extended periods may affect reliability.
2. Up to 9850 ft.
3. If the DRAM case temperature is Above 85°C, the Auto-Refresh command interval has to be reduced to tREFI=3.9us. For Measurement conditions of T<sub>CASE</sub>, please refer to the JEDEC document JESD51-2.

**DC OPERATING CONDITIONS (SSTL\_1.8)**

Symbol	Parameter	Rating			Units	Notes
		Min.	Typ.	Max.		
VDD	Supply Voltage	1.7	1.8	1.9	V	1
VDDL	Supply Voltage for DLL	1.7	1.8	1.9	V	1,2
VDDQ	Supply Voltage for Output	1.7	1.8	1.9	V	1,2
VREF	Input Reference Voltage	0.49*VDDQ	0.50*VDDQ	0.51*VDDQ	mV	3,4
VTT	Termination Voltage	VREF-0.04	VREF	VREF+0.04	V	5
VDDSPD	EEPROM Supply Voltage	1.7	-	3.6	V	

**Note:**

1. Min. Typ. and Max. values increase by 100mV for C3(DDR2-533 3-3-3) speed option.
2. VDDQ tracks with VDD, VDDL tracks with VDD. AC parameters are measured with VDD, VDDQ and VDD.
3. The value of VREF may be selected by the user to provide optimum noise margin in the system. Typically the value of VREF is expected to be about 0.5 x VDDQ of the transmitting device and VREF is expected to track variations in VDDQ.
4. Peak to peak ac noise on VREF may not exceed +/-2% VREF (dc).
5. VTT of transmitting device must track VREF of receiving device.

**INPUT DC LOGIC LEVEL**

Parameter	Symbol	Min	Max	Unit	Note
dc Input logic HIGH	$V_{IH(DC)}$	$V_{REF} + 0.125$	$V_{DDQ} + 0.3$	V	
dc Input logic LOW	$V_{IL(DC)}$	-0.30	$V_{REF} - 0.125$	V	

**INPUT AC LOGIC LEVEL**

Parameter	Symbol	DDR2 400/533		DDR2 667/800		Unit	Notes
		Min	Max	Min	Max		
ac Input logic HIGH	$V_{IH(AC)}$	$V_{REF} + 0.250$	-	$V_{REF} + 0.200$	-	V	
ac Input logic LOW	$V_{IL(AC)}$	-	$V_{REF} - 0.250$	-	$V_{REF} - 0.200$	V	

**AC INPUT TEST CONDITIONS**

Symbol	Condition	Value	Units	Notes
$V_{REF}$	Input reference voltage	$0.5 * V_{DDQ}$	V	1
$V_{SWING(MAX)}$	Input signal maximum peak to peak swing	1.0	V	1
SLEW	Input signal minimum slew rate	1.0	V/ns	2, 3

**Note:**

1. Input waveform timing is referenced to the input signal crossing through the  $V_{REF}$  level applied to the device under test.
2. The input signal minimum slew rate is to be maintained over the range from  $V_{REF}$  max to  $V_{IH(ac)}$  min for rising edges and the range from  $V_{REF}$  min to  $V_{IL(ac)}$  max for falling edges as shown in the below figure.
3. AC timings are referenced with input waveforms switching from  $V_{IL(ac)}$  to  $V_{IH(ac)}$  on the positive transitions and  $V_{IH(ac)}$  to  $V_{IL(ac)}$  on the negative transitions.

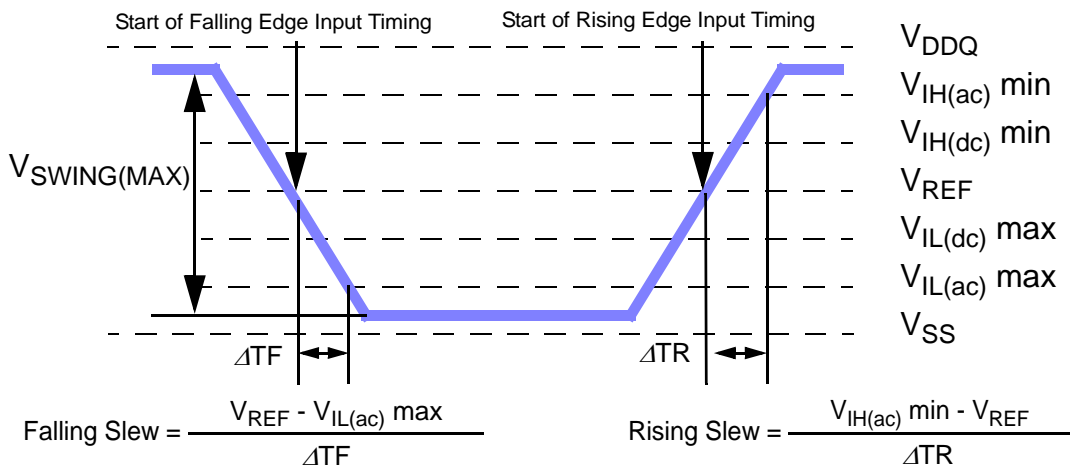

< Figure: AC Input Test Signal Waveform >

### Differential Input AC logic Level

Symbol	Parameter	Min.	Max.	Units	Note
$V_{ID} (ac)$	ac differential input voltage	0.5	$V_{DDQ} + 0.6$	V	1
$V_{IX} (ac)$	ac differential cross point voltage	$0.5 * V_{DDQ} - 0.175$	$0.5 * V_{DDQ} + 0.175$	V	2

**Note:**

- $V_{IN}(DC)$  specifies the allowable DC execution of each input of differential pair such as CK,  $\overline{CK}$ , DQS,  $\overline{DQS}$ , LDQS,  $\overline{LDQS}$ , UDQS and  $\overline{UDQS}$ .
- $V_{ID}(DC)$  specifies the input differential voltage  $|V_{TR} - V_{CP}|$  required for switching, where  $V_{TR}$  is the true input (such as CK, DQS, LDQS or UDQS) level and  $V_{CP}$  is the complementary input (such as  $\overline{CK}$ ,  $\overline{DQS}$ ,  $\overline{LDQS}$  or  $\overline{UDQS}$ ) level. The minimum value is equal to  $V_{IH}(DC) - V_{IL}(DC)$ .

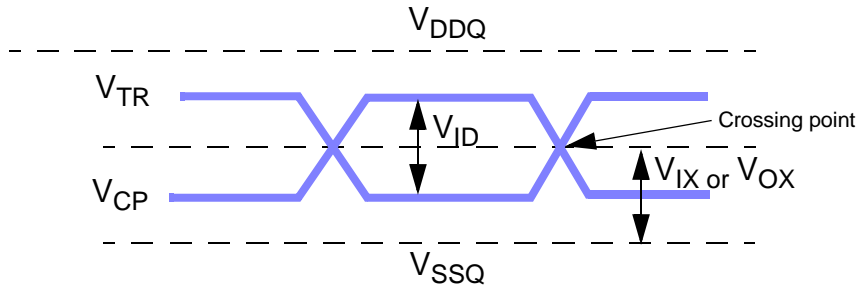

< Differential signal levels >

**Note:**

- $V_{ID}(AC)$  specifies the input differential voltage  $|V_{TR} - V_{CP}|$  required for switching, where  $V_{TR}$  is the true input signal (such as CK, DQS, LDQS or UDQS) and  $V_{CP}$  is the complementary input signal (such as  $\overline{CK}$ ,  $\overline{DQS}$ ,  $\overline{LDQS}$  or  $\overline{UDQS}$ ). The minimum value is equal to  $V_{IH}(AC) - V_{IL}(AC)$ .
- The typical value of  $V_{IX}(AC)$  is expected to be about  $0.5 * V_{DDQ}$  of the transmitting device and  $V_{IX}(AC)$  is expected to track variations in  $V_{DDQ}$ .  $V_{IX}(AC)$  indicates the voltage at which differential input signals must cross.

### DIFFERENTIAL AC OUTPUT PARAMETERS

Symbol	Parameter	Min.	Max.	Units	Note
$V_{OX} (ac)$	ac differential crosspoint voltage	$0.5 * V_{DDQ} - 0.125$	$0.5 * V_{DDQ} + 0.125$	V	1

**Note:**

- The typical value of  $V_{OX}(AC)$  is expected to be about  $0.5 * V_{DDQ}$  of the transmitting device and  $V_{OX}(AC)$  is expected to track variations in  $V_{DDQ}$ .  $V_{OX}(AC)$  indicates the voltage at which differential output signals must cross.

## OUTPUT BUFFER LEVELS

### OUTPUT AC TEST CONDITIONS

Symbol	Parameter	SSTL_18	Units	Notes
$V_{OTR}$	Output Timing Measurement Reference Level	$0.5 * V_{DDQ}$	V	1

**Note:**

1. The VDDQ of the device under test is referenced.

### OUTPUT DC CURRENT DRIVE

Symbol	Parameter	SSTL_18	Units	Notes
$I_{OH(dc)}$	Output Minimum Source DC Current	- 13.4	mA	1, 3, 4
$I_{OL(dc)}$	Output Minimum Sink DC Current	13.4	mA	2, 3, 4

**Note:**

1.  $V_{DDQ} = 1.7$  V;  $V_{OUT} = 1420$  mV.  $(V_{OUT} - V_{DDQ})/I_{OH}$  must be less than 21 ohm for values of  $V_{OUT}$  between  $V_{DDQ}$  and  $V_{DDQ} - 280$  mV.
2.  $V_{DDQ} = 1.7$  V;  $V_{OUT} = 280$  mV.  $V_{OUT}/I_{OL}$  must be less than 21 ohm for values of  $V_{OUT}$  between 0 V and 280 mV.
3. The dc value of  $V_{REF}$  applied to the receiving device is set to  $V_{TT}$
4. The values of  $I_{OH(dc)}$  and  $I_{OL(dc)}$  are based on the conditions given in Notes 1 and 2. They are used to test device drive current capability to ensure  $V_{IH}$  min plus a noise margin and  $V_{IL}$  max minus a noise margin are delivered to an SSTL\_18 receiver. The actual current values are derived by shifting the desired driver operating point along a 21 ohm load line to define a convenient driver current for measurement.

**PIN Capacitance** (VDD=1.8V, VDDQ=1.8V, TA=25°C)

**1GB: HYMP112[R,P]72CP8**

Pin	Symbol	Min	Max	Unit
CK0, /CK0	CCK	7	11	pF
CKE, ODT	CI1	8	12	pF
/CS	CI2	8	12	pF
Address, /RAS, /CAS, /WE	CI3	8	12	pF
DQ, DM, DQS, /DQS	CIO	6	9	pF

**2GB: HYMP125P72CP8**

Pin	Symbol	Min	Max	Unit
CK0, /CK0	CCK	TBD	TBD	pF
CKE, ODT	CI1	TBD	TBD	pF
/CS	CI2	TBD	TBD	pF
Address, /RAS, /CAS, /WE	CI3	TBD	TBD	pF
DQ, DM, DQS, /DQS	CIO	TBD	TBD	pF

**2GB: HYMP125[R,P]72CP4**

Pin	Symbol	Min	Max	Unit
CK0, /CK0	CCK	7	11	pF
CKE, ODT	CI1	8	12	pF
/CS	CI2	10	15	pF
Address, /RAS, /CAS, /WE	CI3	8	12	pF
DQ, DM, DQS, /DQS	CIO	6	9	pF

**4GB: HYMP151P72CP8**

Pin	Symbol	Min	Max	Unit
CK0, /CK0	CCK	TBD	TBD	pF
CKE, ODT	CI1	TBD	TBD	pF
/CS	CI2	TBD	TBD	pF
Address, /RAS, /CAS, /WE	CI3	TBD	TBD	pF
DQ, DM, DQS, /DQS	CIO	TBD	TBD	pF



**4GB: HYMP151[R,P]72CP4**

Pin	Symbol	Min	Max	Unit
CK0, /CK0	CCK	7	11	pF
CKE, ODT	CI1	10	15	pF
/CS	CI2	10	15	pF
Address, /RAS, /CAS, /WE	CI3	10	15	pF
DQ, DM, DQS, /DQS	CIO	9	15	pF

**8GB: HYMP31G[R,P]72CMP4**

Pin	Symbol	Min	Max	Unit
CK0, /CK0	CCK	7	11	pF
CKE, ODT	CI1	8	12	pF
/CS	CI2	8	12	pF
Address, /RAS, /CAS, /WE	CI3	10	15	pF
DQ, DM, DQS, /DQS	CIO	18	22	pF

**Note:**

1. Pins not under test are tied to GND.
2. These value are guaranteed by design and tested on a sample basis only.

**IDD SPECIFICATIONS** (T<sub>CASE</sub>: 0 to 95°C)

**1GB, 128M x 72 Registered DIMM: HYMP112[R,P]72CP8**

Symbol	E3 (DDR2 400@CL3)	C4 (DDR2 533@CL4)	Y5 (DDR2 667@CL5)	S5 /S6 (DDR2 800@CL5&6)	Unit	Note
IDD0	1190	1235	1280	1325	mA	
IDD1	1280	1325	1370	1415	mA	
IDD2P	740	740	740	740	mA	
IDD2Q	848	893	920	938	mA	
IDD2N	920	965	1010	1055	mA	
IDD3P(F)	830	830	875	875	mA	
IDD3P(S)	758	758	758	758	mA	
IDD3N	965	1055	1100	1145	mA	
IDD4R	1550	1775	2045	2270	mA	
IDD4W	1550	1775	2000	2180	mA	
IDD5B	2135	2135	2225	2270	mA	
IDD6	540	540	540	540	mA	1
IDD7	2135	2225	2450	2765	mA	

**2GB, 256M x 72 Registered DIMM: HYMP125P72CP8**

Symbol	E3 (DDR2 400@CL3)	C4 (DDR2 533@CL4)	Y5 (DDR2 667@CL5)	S5 /S6 (DDR2 800@CL5&6)	Unit	Note
IDD0	1460	1550	1640	1730	mA	
IDD1	1550	1640	1730	1820	mA	
IDD2P	830	830	830	830	mA	
IDD2Q	1046	1136	1190	1226	mA	
IDD2N	1190	1280	1370	1460	mA	
IDD3P(F)	1010	1010	1100	1100	mA	
IDD3P(S)	866	866	866	866	mA	
IDD3N	1280	1460	1550	1640	mA	
IDD4R	1820	2090	2405	2675	mA	
IDD4W	1820	2090	2360	2585	mA	
IDD5B	2405	2450	2585	2675	mA	
IDD6	630	630	630	630	mA	1
IDD7	2405	2540	2810	3170	mA	

**Note:** 1. IDD6 current values are guaranteed up to Tcase of 85°C max.

**2GB, 256M x 72 Registered DIMM: HYMP125[R,P]72CP4**

Symbol	E3 (DDR2 400@CL3)	C4 (DDR2 533@CL4)	Y5 (DDR2 667@CL5)	S5 /S6 (DDR2 800@CL5&6)	Unit	Note
IDD0	1730	1820	1910	2000	mA	
IDD1	1910	2000	2090	2180	mA	
IDD2P	830	830	830	830	mA	
IDD2Q	1046	1136	1190	1226	mA	
IDD2N	1190	1280	1370	1460	mA	
IDD3P(F)	1010	1010	1100	1100	mA	
IDD3P(S)	866	866	866	866	mA	
IDD3N	1280	1460	1550	1640	mA	
IDD4R	2450	2900	3440	3890	mA	
IDD4W	2450	2900	3600	3710	mA	
IDD5B	3620	3620	3800	3690	mA	
IDD6	630	630	630	630	mA	1
IDD7	3620	3800	4250	4880	mA	

**4GB, 512M x 72 Registered DIMM: HYMP151P72CP8**

Symbol	E3 (DDR2 400@CL3)	C4 (DDR2 533@CL4)	Y5 (DDR2 667@CL5)	S5 /S6 (DDR2 800@CL5&6)	Unit	Note
IDD0	2000	2180	2360	2540	mA	
IDD1	2090	2270	2450	2630	mA	
IDD2P	1010	1010	1010	1010	mA	
IDD2Q	1442	1622	1730	1802	mA	
IDD2N	1730	1910	1090	2270	mA	
IDD3P(F)	1370	1370	1550	1550	mA	
IDD3P(S)	1082	1082	1082	1082	mA	
IDD3N	1910	2270	2450	2630	mA	
IDD4R	2360	2720	3125	3485	mA	
IDD4W	2360	2720	3080	3395	mA	
IDD5B	2945	3080	3305	3485	mA	
IDD6	810	810	810	810	mA	1
IDD7	2945	3170	3530	3980	mA	

**Note:** 1. IDD6 current values are guaranteed up to Tcase of 85°C max.

**4GB, 512M x 72 Registered DIMM: HYMP151[R,P]72CP4**

Symbol	E3 (DDR2 400@CL3)	C4 (DDR2 533@CL4)	Y5 (DDR2 667@CL5)	S5 /S6 (DDR2 800@CL5&6)	Unit	Note
IDD0	2270	2450	2630	2810	mA	
IDD1	2450	2630	2810	2990	mA	
IDD2P	1010	1010	1010	1010	mA	
IDD2Q	1442	1622	1730	1802	mA	
IDD2N	1730	1910	2090	2270	mA	
IDD3P(F)	1370	1370	1550	1550	mA	
IDD3P(S)	1082	1082	1082	1082	mA	
IDD3N	1910	2270	2450	2630	mA	
IDD4R	2990	3530	4160	4700	mA	
IDD4W	2990	3530	4070	1520	mA	
IDD5B	4160	4250	4520	4700	mA	
IDD6	810	810	810	810	mA	1
IDD7	4160	4430	4970	5690	mA	

**8GB, 1G x 72 Registered DIMM: HYMP31G[R,P]72CMP4**

Symbol	C4 (DDR2 533@CL4)	Y5 (DDR2 667@CL5)	Unit	Note
IDD0	3710	4070	mA	
IDD1	3890	4250	mA	
IDD2P	1370	1370	mA	
IDD2Q	2594	2810	mA	
IDD2N	3170	3530	mA	
IDD3P(F)	2090	2450	mA	
IDD3P(S)	1514	1514	mA	
IDD3N	3890	4250	mA	
IDD4R	4790	5600	mA	
IDD4W	4790	5510	mA	
IDD5B	5510	5960	mA	
IDD6	1170	1170	mA	1
IDD7	5690	6410	mA	

**Note:** 1. IDD6 current values are guaranteed up to Tcase of 85°C max.

## IDD Measurement Conditions

Symbol	Conditions	Units	
IDD0	<b>Operating one bank active-precharge current;</b> $t_{CK} = t_{CK}(IDD)$ , $t_{RC} = t_{RC}(IDD)$ , $t_{RAS} = t_{RASmin}(IDD)$ ; CKE is HIGH, $\overline{CS}$ is HIGH between valid commands; Address bus inputs are SWITCHING; Data bus inputs are SWITCHING	mA	
IDD1	<b>Operating one bank active-read-precharge current;</b> $I_{OUT} = 0mA$ ; $BL = 4$ , $CL = CL(IDD)$ , $AL = 0$ ; $t_{CK} = t_{CK}(IDD)$ , $t_{RC} = t_{RC}(IDD)$ , $t_{RAS} = t_{RASmin}(IDD)$ , $t_{RCD} = t_{RCD}(IDD)$ ; CKE is HIGH, $\overline{CS}$ is HIGH between valid commands; Address bus inputs are SWITCHING; Data pattern is same as IDD4W	mA	
IDD2P	<b>Precharge power-down current;</b> All banks idle; $t_{CK} = t_{CK}(IDD)$ ; CKE is LOW; Other control and address bus inputs are STABLE; Data bus inputs are FLOATING	mA	
IDD2Q	<b>Precharge quiet standby current;</b> All banks idle; $t_{CK} = t_{CK}(IDD)$ ; CKE is HIGH, $\overline{CS}$ is HIGH; Other control and address bus inputs are STABLE; Data bus inputs are FLOATING	mA	
IDD2N	<b>Precharge standby current;</b> All banks idle; $t_{CK} = t_{CK}(IDD)$ ; CKE is HIGH, $\overline{CS}$ is HIGH; Other control and address bus inputs are SWITCHING; Data bus inputs are SWITCHING	mA	
IDD3P	<b>Active power-down current;</b> All banks open; $t_{CK} = t_{CK}(IDD)$ ; CKE is LOW; Other control and address bus inputs are STABLE; Data bus inputs are FLOATING	Fast PDN Exit MRS(12) = 0	mA
		Slow PDN Exit MRS(12) = 1	mA
IDD3N	<b>Active standby current;</b> All banks open; $t_{CK} = t_{CK}(IDD)$ , $t_{RAS} = t_{RASmax}(IDD)$ , $t_{RP} = t_{RP}(IDD)$ ; CKE is HIGH, $\overline{CS}$ is HIGH between valid commands; Other control and address bus inputs are SWITCHING; Data bus inputs are SWITCHING	mA	
IDD4W	<b>Operating burst write current;</b> All banks open, Continuous burst writes; $BL = 4$ , $CL = CL(IDD)$ , $AL = 0$ ; $t_{CK} = t_{CK}(IDD)$ , $t_{RAS} = t_{RASmax}(IDD)$ , $t_{RP} = t_{RP}(IDD)$ ; CKE is HIGH, $\overline{CS}$ is HIGH between valid commands; Address bus inputs are SWITCHING; Data bus inputs are SWITCHING	mA	
IDD4R	<b>Operating burst read current;</b> All banks open, Continuous burst reads, $I_{OUT} = 0mA$ ; $BL = 4$ , $CL = CL(IDD)$ , $AL = 0$ ; $t_{CK} = t_{CK}(IDD)$ , $t_{RAS} = t_{RASmax}(IDD)$ , $t_{RP} = t_{RP}(IDD)$ ; CKE is HIGH, $\overline{CS}$ is HIGH between valid commands; Address bus inputs are SWITCHING; Data pattern is same as IDD4W	mA	
IDD5B	<b>Burst refresh current;</b> $t_{CK} = t_{CK}(IDD)$ ; Refresh command at every $t_{RFC}(IDD)$ interval; CKE is HIGH, $\overline{CS}$ is HIGH between valid commands; Other control and address bus inputs are SWITCHING; Data bus inputs are SWITCHING	mA	
IDD6	<b>Self refresh current;</b> CK and $\overline{CK}$ at 0V; $CKE \leq 0.2V$ ; Other control and address bus inputs are FLOATING; Data bus inputs are FLOATING. IDD6 current values are guaranteed up to Tcase of 85 max.	mA	
IDD7	<b>Operating bank interleave read current;</b> All bank interleaving reads, $I_{OUT} = 0mA$ ; $BL = 4$ , $CL = CL(IDD)$ , $AL = t_{RCD}(IDD) - 1 * t_{CK}(IDD)$ ; $t_{CK} = t_{CK}(IDD)$ , $t_{RC} = t_{RC}(IDD)$ , $t_{RRD} = t_{RRD}(IDD)$ , $t_{RCD} = 1 * t_{CK}(IDD)$ ; CKE is HIGH, $\overline{CS}$ is HIGH between valid commands; Address bus inputs are STABLE during DESELECTs; Data pattern is same as IDD4R; - Refer to the following page for detailed timing conditions	mA	

### Note:

1. IDD specifications are tested after the device is properly initialized
2. Input slew rate is specified by AC Parametric Test Condition
3. IDD parameters are specified with ODT disabled.
4. Data bus consists of DQ, DM, DQS,  $\overline{DQS}$ , RDQS,  $\overline{RDQS}$ , LDQS,  $\overline{LDQS}$ , UDQS, and  $\overline{UDQS}$ . IDD values must be met with all combinations of EMRS bits 10 and 11.
5. Definitions for IDD
  - LOW is defined as  $V_{in} \leq V_{ILAC}(\text{max})$
  - HIGH is defined as  $V_{in} \geq V_{IHAC}(\text{min})$
  - STABLE is defined as inputs stable at a HIGH or LOW level
  - FLOATING is defined as inputs at  $V_{REF} = V_{DDQ}/2$
  - SWITCHING is defined as: inputs changing between HIGH and LOW every other clock cycle (once per two clocks) for address and control signals, and inputs changing between HIGH and LOW every other data transfer (once per clock) for DQ signals not including masks or strobes

## Electrical Characteristics & AC Timings

Speed Bins and CL, tRCD, tRP, tRC and tRAS for Corresponding Bin

Speed	DDR2-800 (S5)	DDR2-667 (Y5)	DDR2-533 (C4)	DDR2-400 (E3)	Unit
Bin (CL-tRCD-tRP)	5-5-5	5-5-5	4-4-4	3-3-3	
Parameter	min	min	min	min	
CAS Latency	5	5	4	3	ns
tRCD	12.5	15	15	15	ns
tRP	12.5	15	15	15	ns
tRC	57.5	60	60	55	ns
tRAS	45	45	45	40	ns

### AC Timing Parameters by Speed Grade (DDR2-400 & DDR2-533)

Parameter	Symbol	DDR2-400		DDR2-533		Unit	Note
		Min	Max	Min	Max		
Data-Out edge to Clock edge Skew	tAC	-600	600	-500	500	ps	
DQS-Out edge to Clock edge Skew	tDQSCK	-500	500	-500	450	ns	
Clock High Level Width	tCH	0.45	0.55	0.45	0.55	CK	
Clock Low Level Width	tCL	0.45	0.55	0.45	0.55	CK	
Clock Half Period	tHP	min (tCL, tCH)	-	min (tCL, tCH)	-	ns	
System Clock Cycle Time	tCK	5000	8000	3750	8000	ps	
DQ and DM input setup time	tDS	150	-	100	-	ps	1
DQ and DM input hold time	tDH	275	-	225	-	ps	1
Control & Address input Pulse Width for each input	tIPW	0.6	-	0.6	-	tCK	
DQ and DM input pulse width for each input pulse width for each input	tDIPW	0.35	-	0.35	-	tCK	
Data-out high-impedance window from CK, /CK	tHZ	-	tAC max	-	tAC max	ps	
DQS low-impedance time from CK/ $\overline{\text{CK}}$	tLZ(DQS)	tAC min	tAC max	tAC min	tAC max	ps	
DQ low-impedance time from CK/ $\overline{\text{CK}}$	tLZ(DQ)	2*tAC min	tAC max	2*tAC min	tAC max	ps	
DQS-DQ skew for DQS and associated DQ signals	tDQSQ	-	350	-	300	ps	
DQ hold skew factor	tQHS	-	450	-	400	ps	
DQ/DQS output hold time from DQS	tQH	tHP - tQHS	-	tHP - tQHS	-	ps	
Write command to first DQS latching transition	tDQSS	WL - 0.25	WL + 0.25	WL - 0.25	WL + 0.25	tCK	
DQS input high pulse width	tDQSH	0.35	-	0.35	-	tCK	
DQS input low pulse width	tDQSL	0.35	-	0.35	-	tCK	
DQS falling edge to CK setup time	tDSS	0.2	-	0.2	-	tCK	
DQS falling edge hold time from CK	tDSH	0.2	-	0.2	-	tCK	
Mode register set command cycle time	tMRD	2	-	2	-	tCK	
Write preamble	tWPRE	0.35	-	0.35	-	tCK	

Parameter	Symbol	DDR2-400		DDR2-533		Unit	Note
		Min	Max	Min	Max		
Write postamble	tWPST	0.4	0.6	0.4	0.6	tCK	
Address and control input setup time	tIS	350	-	250	-	ps	
Address and control input hold time	tIH	475	-	375	-	ps	
Read preamble	tRPRE	0.9	1.1	0.9	1.1	tCK	
Read postamble	tRPST	0.4	0.6	0.4	0.6	tCK	
Auto-Refresh to Active/Auto-Refresh command period	tRFC	127.5	-	127.5	-	ns	
Row Active to Row Active Delay for 1KB page size	tRRD	7.5	-	7.5	-	ns	
Row Active to Row Active Delay for 2KB page size	tRRD	10	-	10	-	ns	
Four Activate Window for 1KB page size	tFAW	37.5	-	37.5	-	ns	
Four Activate Window for 2KB page size	tFAW	50	-	50	-	ns	
CAS to CAS command delay	tCCD	2		2		tCK	
Write recovery time	tWR	15	-	15	-	ns	
Auto Precharge Write Recovery + Precharge Time	tDAL	tWR + tRP	-	tWR + tRP	-	tCK	
Write to Read Command Delay	tWTR	10	-	7.5	-	ns	
Internal read to precharge command delay	tRTP	7.5		7.5		ns	
Exit self refresh to a non-read command	tXSNR	tRFC + 10		tRFC + 10		ns	
Exit self refresh to a read command	tXSRD	200	-	200	-	tCK	
Exit precharge power down to any non-read command	tXP	2	-	2	-	tCK	
Exit active power down to read command	tXARD	2		2		tCK	
Exit active power down to read command (Slow exit, Lower power)	tXARDS	6 - AL		6 - AL		tCK	
CKE minimum pulse width (high and low pulse width)	tCKE	3		3		tCK	
ODT turn-on delay	tAOND	2	2	2	2	tCK	
ODT turn-on	tAON	tAC (min)	tAC(max)+1	tAC (min)	tAC(max)+1	ns	
ODT turn-on (Power-Down mode)	tAONPD	tAC(min)+2	2tCK+tAC(max)+1	tAC(min)+2	2tCK+tAC(max)+1	ns	
ODT turn-off delay	tAOFD	2.5	2.5	2.5	2.5	tCK	
ODT turn-off	tAOF	tAC (min)	tAC (max)+0.6	tAC (min)	tAC (max)+0.6	ns	
ODT turn-off (Power-Down mode)	tAOFPD	tAC(min)+2	2.5tCK+tAC(max)+1	tAC(min)+2	2.5tCK+tAC(max)+1	ns	
ODT to power down entry latency	tANPD	3		3		tCK	
ODT power down exit latency	tAXPD	8		8		tCK	
OCD drive mode output delay	tOIT	0	12	0	12	ns	
Minimum time clocks remains ON after CKE asynchronously drops LOW	tDelay	tIS + tCK + tIH		tIS + tCK + tIH		ns	
Average periodic Refresh Interval	tREFI	-	7.8	-	7.8	us	2
	tREFI	-	3.9	-	3.9	us	3

**Note:**

- For details and notes, please refer to the relevant HYNIX component datasheet HY5PS1G[4,8]31CFP.
- 0°C  $T_{CASE}$  85°C
- 85°C <  $T_{CASE}$  95°C

**(DDR2-667 & DDR2-800)**

Parameter	Symbol	DDR2-667		DDR2-800		Unit	Note
		min	max	min	max		
DQ output access time from $\overline{CK}/\overline{CK}$	tAC	-450	+450	-400	+400	ps	
DQS output access time from $\overline{CK}/\overline{CK}$	tDQSCK	-400	+400	-350	+350	ps	
CK high-level width	tCH	0.45	0.55	0.45	0.55	tCK	
CK low-level width	tCL	0.45	0.55	0.45	0.55	tCK	
CK half period	tHP	min(tCL, tCH)	-	min(tCL, tCH)	-	ps	
Clock cycle time, CL=x	tCK	3000	8000	2500		ps	
DQ and DM input setup time (differential strobe)	tDS	100	-	50	-	ps	1
DQ and DM input hold time (differential strobe)	tDH	175	-	125	-	ps	1
Control & Address input pulse width for each input	tIPW	0.6	-	0.6	-	tCK	
DQ and DM input pulse width for each input	tDIPW	0.35	-	0.35	-	tCK	
Data-out high-impedance time from $\overline{CK}/\overline{CK}$	tHZ	-	tAC max	-	tAC max	ps	
DQS low-impedance time from $\overline{CK}/\overline{CK}$	tLZ(DQS)	tAC min	tAC max	tAC min	tAC max	ps	
DQ low-impedance time from $\overline{CK}/\overline{CK}$	tLZ(DQ)	2*tAC min	tAC max	2*tAC min	tAC max	ps	
DQS-DQ skew for DQS and associated DQ signals	tDQSQ	-	240	-	200	ps	
DQ hold skew factor	tQHS	-	340	-	300	ps	
DQ/DQS output hold time from DQS	tQH	tHP - tQHS	-	tHP - tQHS	-	ps	
First DQS latching transition to associated clock edge	tDQSS	- 0.25	+ 0.25	- 0.25	+ 0.25	tCK	
DQS input high pulse width	tDQSH	0.35	-	0.35	-	tCK	
DQS input low pulse width	tDQSL	0.35	-	0.35	-	tCK	
DQS falling edge to CK setup time	tDSS	0.2	-	0.2	-	tCK	
DQS falling edge hold time from CK	tDSH	0.2	-	0.2	-	tCK	
Mode register set command cycle time	tMRD	2	-	2	-	tCK	
Write preamble	tWPRE	0.35	-	0.35	-	tCK	
Write postamble	tWPST	0.4	0.6	0.4	0.6	tCK	
Auto-Refresh to Active/Auto-Refresh command period	tRFC	127.5	-	127.5	-	ns	
Row Active to Row Active Delay for 1KB page size	tRRD	7.5	-	7.5	-	ns	
Address and control input setup time	tIS	200	-	175	-	ps	
Address and control input hold time	tIH	275	-	250	-	ps	
Read preamble	tRPRE	0.9	1.1	0.9	1.1	tCK	
Read postamble	tRPST	0.4	0.6	0.4	0.6	tCK	
Activate to precharge command	tRAS	45	70000	45	70000	ns	
Active to active command period for 1KB page size products	tRRD	7.5	-	7.5	-	ns	
Row Active to Row Active Delay for 2KB page size	tRRD	10	-	10	-	ns	
Four Active Window for 1KB page size products	tFAW	37.5	-	35	-	ns	
Four Activate Window for 2KB page size	tFAW	50	-	50	-	ns	
CAS to $\overline{CAS}$ command delay	tCCD	2	-	2	-	tCK	
Write recovery time	tWR	15	-	15	-	ns	
Auto precharge write recovery + precharge time	tDAL	WR+tRP	-	WR+tRP	-	tCK	
Internal write to read command delay	tWTR	7.5	-	7.5	-	ns	
Internal read to precharge command delay	tRTP	7.5	-	7.5	-	ns	



Parameter	Symbol	DDR2-667		DDR2-800		Unit	Note
		min	max	min	max		
Exit self refresh to a non-read command	tXSNR	tRFC + 10		tRFC + 10		ns	
Exit self refresh to a read command	tXSRD	200	-	200	-	tCK	
Exit precharge power down to any non-read command	tXP	2	-	2	-	tCK	
Exit active power down to read command	tXARD	2		2		tCK	
Exit active power down to read command (Slow exit, Lower power)	tXARDS	7 - AL		8 - AL		tCK	
CKE minimum pulse width (high and low pulse width)	tCKE	3		3		tCK	
ODT turn-on delay	tAOND	2	2	2	2	tCK	
ODT turn-on	tAON	tAC (min)	tAC (max) + 0.7	tAC (min)	tAC (max) + 0.7	ns	
ODT turn-on (Power-Down mode)	tAONPD	tAC(min)+2	2tCK+tAC(max)+1	tAC (min) + 2	2tCK+tAC(max)+1	ns	
ODT turn-off delay	tAOFD	2.5	2.5	2.5	2.5	tCK	
ODT turn-off	tAOF	tAC (min)	tAC (max) + 0.6	tAC (min)	tAC (max) + 0.6	ns	
ODT turn-off (Power-Down mode)	tAOFPD	tAC (min) + 2	2.5tCK+tAC(max)+1	tAC (min) + 2	2.5tCK+tAC(max)+1	ns	
ODT to power down entry latency	tANPD	3		3		tCK	
ODT power down exit latency	tAXPD	8		8		tCK	
OCD drive mode output delay	tOIT	0	12	0	12	ns	
Minimum time clocks remains ON after CKE asynchronously drops LOW	tDelay	tIS + tCK + tIH		tIS + tCK + tIH		ns	
Average periodic Refresh Interval	tREFI	-	7.8	-	7.8	us	2
	tREFI	-	3.9	-	3.9	us	3

**Note:**

- For details and notes, please refer to the relevant HYNIX component datasheet HY5PS1G[4,8]31CFP.
- 0°C  $T_{CASE}$  85°C
- 85°C <  $T_{CASE}$  95°C

**DIMM OUTLINE**

128Mx72 (1 rank) - HYMP112[R,P]72CP8

**Front**

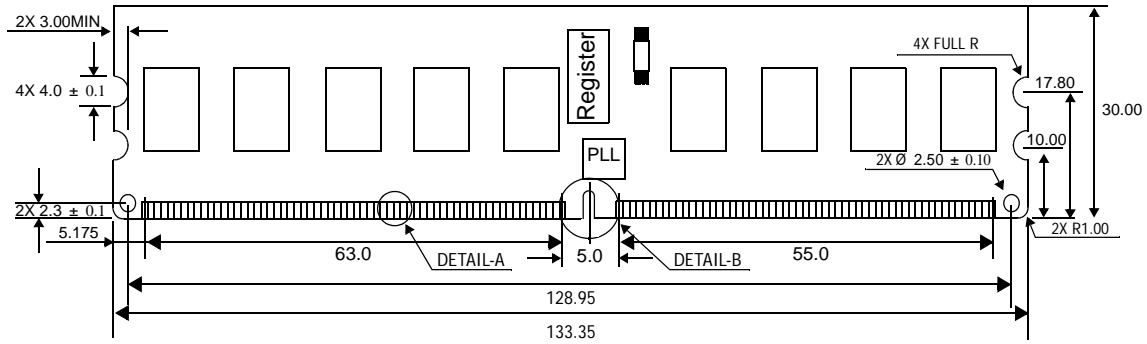

**Back**

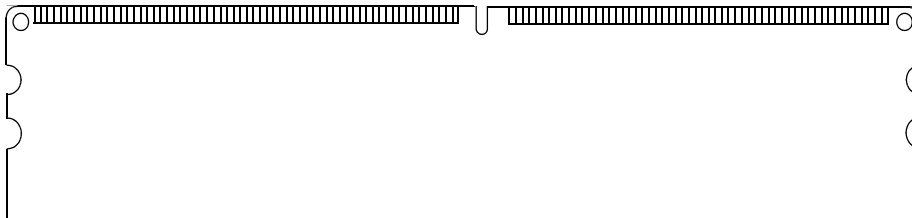

Detail of Contacts A

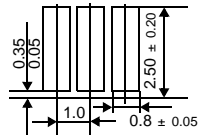

Detail of Contacts B

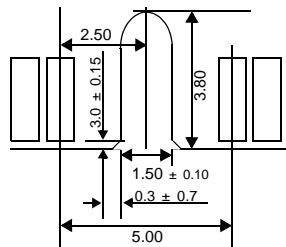

Side

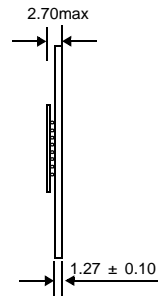

Note) All dimensions are typical unless otherwise stated.  $\frac{\text{Millimeters}}{\text{Inches}}$

**DIMM OUTLINE**  
**256Mx72 (2 rank) - HYMP125P72CP8**

**Front**

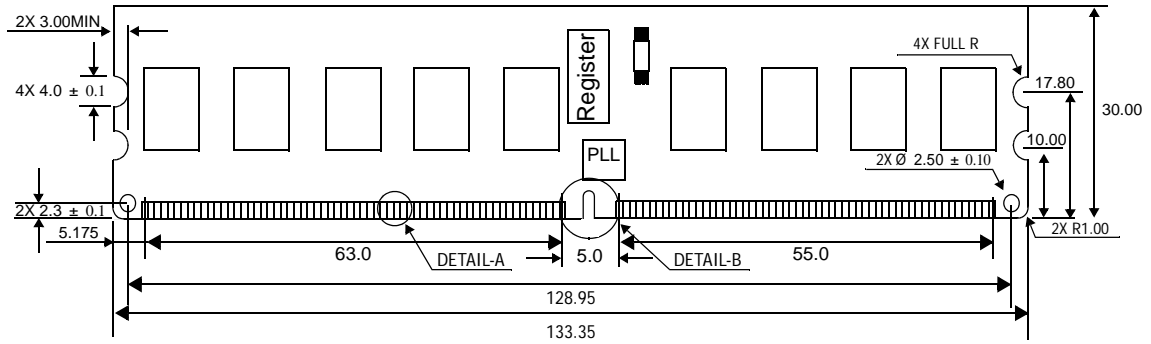

**Back**

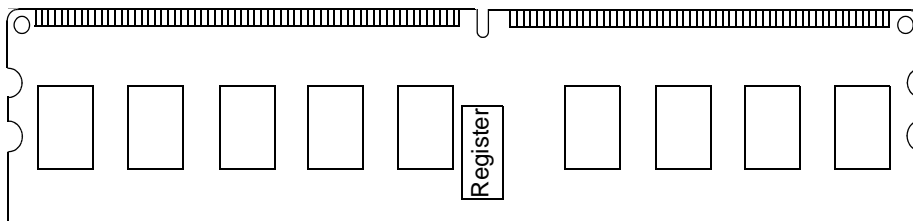

**Detail of Contacts A**

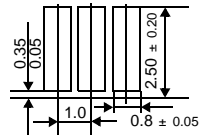

**Detail of Contacts B**

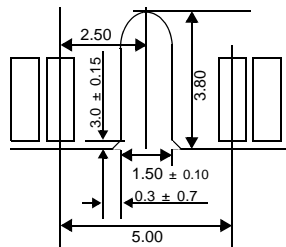

**Side**

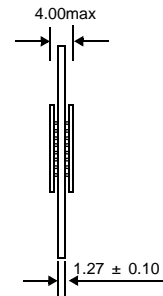

Note) All dimensions are typical unless otherwise stated.  $\frac{\text{Millimeters}}{\text{Inches}}$

**DIMM OUTLINE**  
**256Mx72 (1 rank) - HYMP125[R,P]72CP4**

**Front**

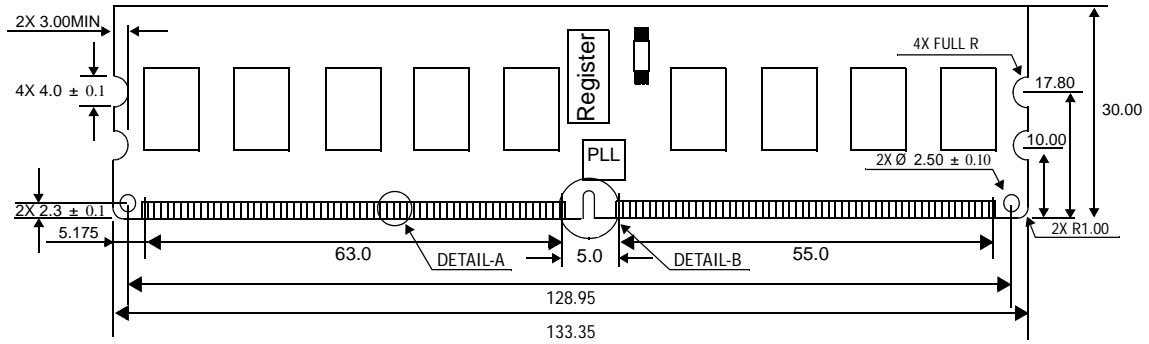

**Back**

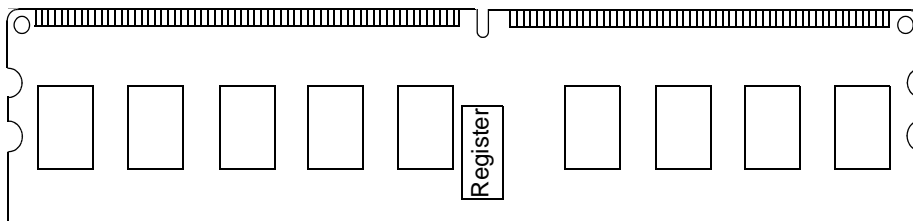

**Detail of Contacts A**

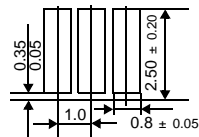

**Detail of Contacts B**

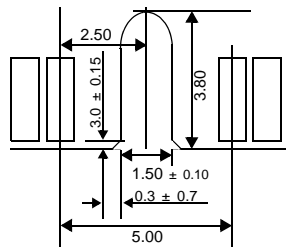

**Side**

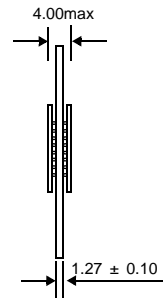

Note) All dimensions are typical unless otherwise stated.  $\frac{\text{Millimeters}}{\text{Inches}}$

DIMM OUTLINE

512Mx72 (4 ranks) - HYMP151P72CP8

Front

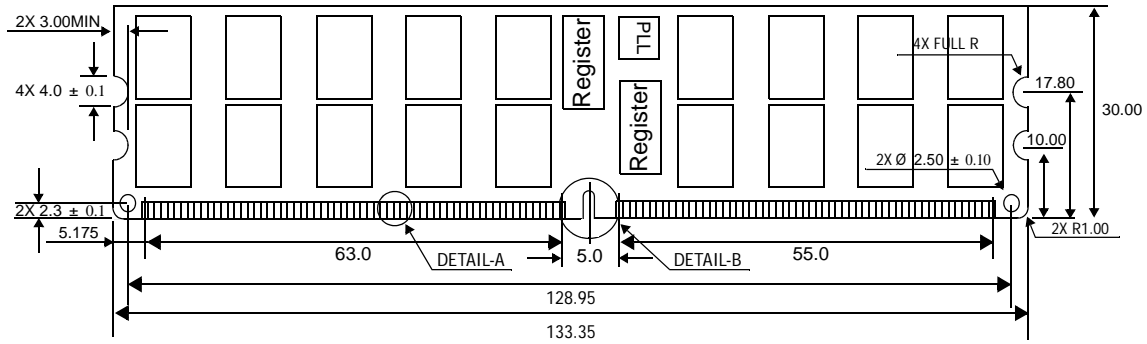

Back

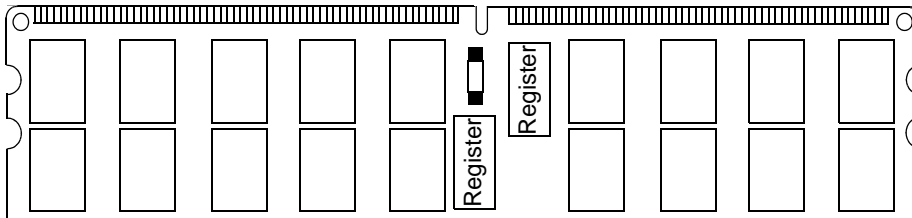

Detail of Contacts A

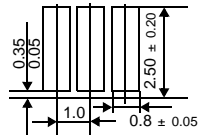

Detail of Contacts B

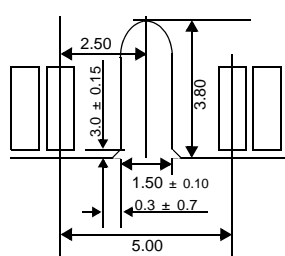

Side

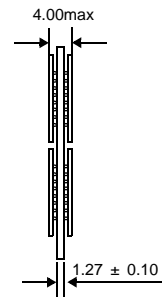

Note) All dimensions are typical unless otherwise stated.  $\frac{\text{Millimeters}}{\text{Inches}}$

**DIMM OUTLINE**

512Mx72 (2 ranks) - HYMP151[R,P]72CP4

**Front**

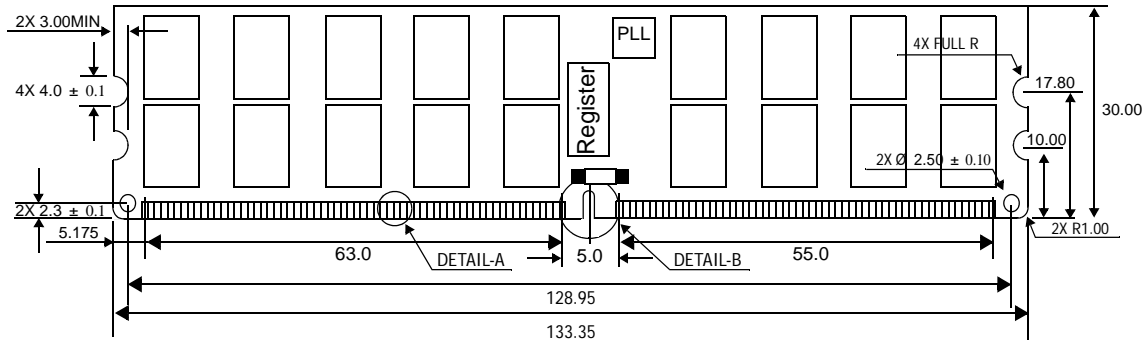

**Back**

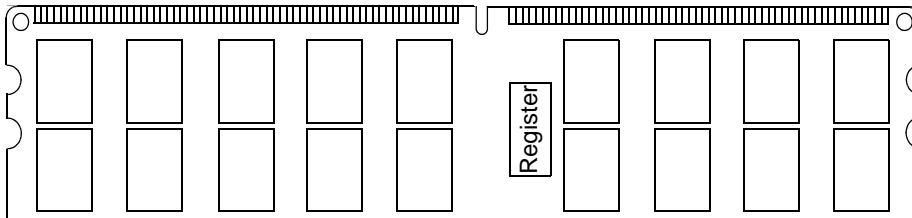

Detail of Contacts A

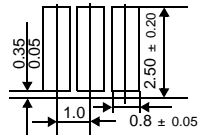

Detail of Contacts B

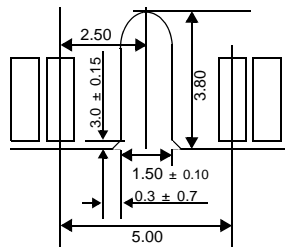

Side

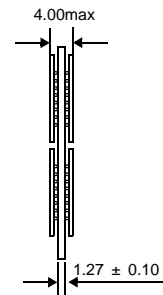

Note) All dimensions are typical unless otherwise stated.  $\frac{\text{Millimeters}}{\text{Inches}}$

**DIMM OUTLINE**

**1Gx72 (4 ranks) - HYMP31GP72CMP4**

**Front**

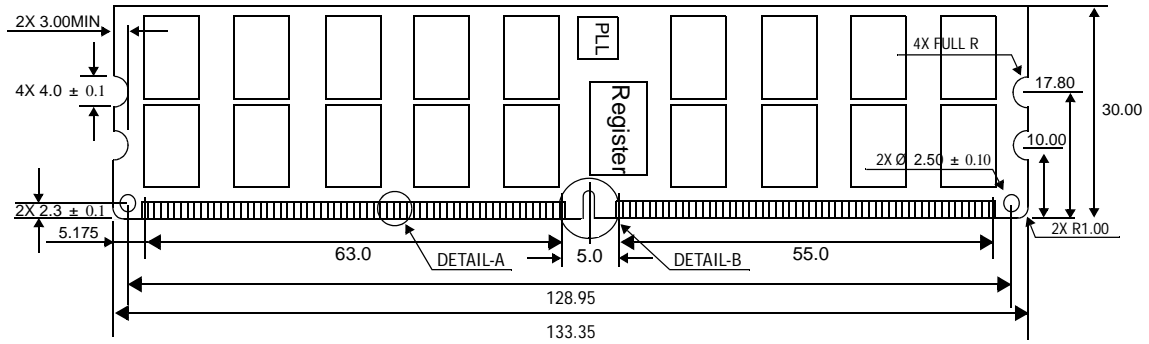

**Back**

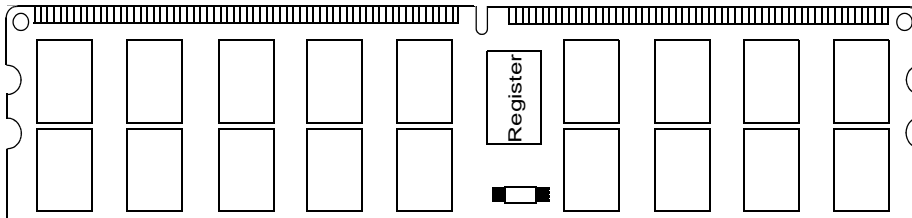

Detail of Contacts A

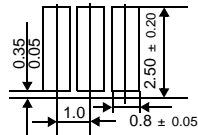

Detail of Contacts B

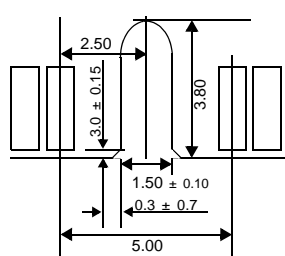

Side

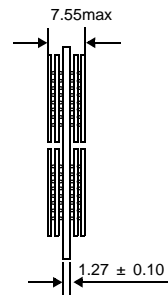

Note) All dimensions are typical unless otherwise stated.  $\frac{\text{Millimeters}}{\text{Inches}}$

**REVISION HISTORY**

<b>Revision</b>	<b>History</b>	<b>Date</b>
0.1	Initial data sheet released	May. 2007
0.2	IDD updated	Jun. 2007
0.3	S6 items added and IDD adjusted	Sep. 2007
0.4	Corrected Typos	Nov. 2007
0.5	Added HYMP31GP72CMP4, HYMP151P72CP8, HYMP125P72CP8	Apr. 2008
0.6	IDD Updated	Mar. 2009
0.7	DIMM Outline Corrected	Jun. 2009